

# ARIAL BATTANT



Gamme Signature



Plein



Battant



Prix moyen

## Nuancier



+ Nuancier RAL  
hors-standard  
en option



## Labels



Thermolaquage  
haute durabilité  
CLASSE 2

# Caractéristiques techniques

## Design :

Lignes fluides et épurées.  
Finitions parfaites : poignée et rosace en aluminium anodisé.  
Personnalisation grâce à de nombreux décors disponibles.  
Possibilité d'assortir sa clôture à son portail pour un extérieur parfaitement coordonné.

## Remplissage :

Lame large 255 x 18 (horizontal et vertical).  
Lame large 170 x 18 (horizontal et vertical).  
Lame brise-vent 150 x 25 (horizontal et vertical).

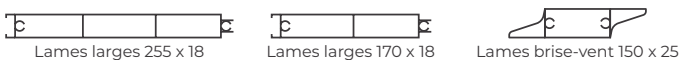

## Dimensions :

Min H 900 x L 2000 mm pour toutes lames.  
Max H 2000 x L 5000 mm (crapaudines incluses à partir de 4251 mm) pour les lames 255 et 170.  
Max H 2000 x L 4250 mm pour les lames brise-vent.

## Structure technique :

Assemblage tenon-mortaise.  
Montant 110 x 70.  
Traverse 100 x 40.  
Oreille de gond profilée.

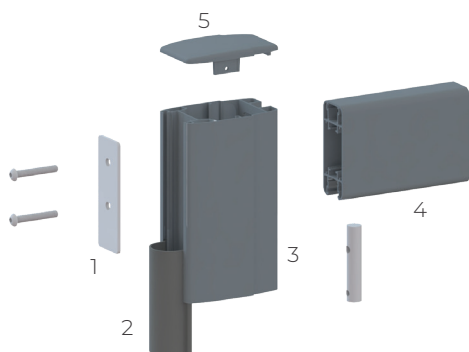

1- Cale 118 x 40 x 4  
2- Joint anti-pince-doigts

4- Traverse 100 x 40  
5- Chapeau de finition extraplat

## Sécurité :

Vis et système anti-dégondage.  
Joint anti pince-doigts.

## Accessoires fournis :

Gonds à visser 2 points avec cache ou à sceller réglables inox disposition type A.  
Serrure avec barillet finition Oxyloc 5 clés.  
Poignée et rosace pour barillet en aluminium anodisé.  
Sabot arrêt central pour portail.  
Arrêt à bascule.  
Pivot crapaudine suivant dimension.  
Visserie de pose en inox incluse.  
Réhausse de sabot.

## Options :

Numéro de rue.  
Bâton de maréchal.

## Motorisation :

V418 - BA 392\* - E770 - Axovia\* - MI24  
Motorisation connectée : box Tydom Home Deltadore, box Tahoma Somfy.

\* (renfort en traverse basse uniquement sur ce modèle en raison de la position des décors)

## Poteaux :

150 M avec embase.  
150 et 200 M avec scellement.

## Types de pose :

A : Gond 2 points entre piliers  
C : Pivot crapaudine entre piliers  
H : Gond pour pente entre piliers  
D : Gond 3 points  
F : Gond 3 points arrière piliers  
G : Pivot crapaudine arrière piliers

# Personnalisation

■ Emplacement des zones de décor pour le portail battant Ariel.

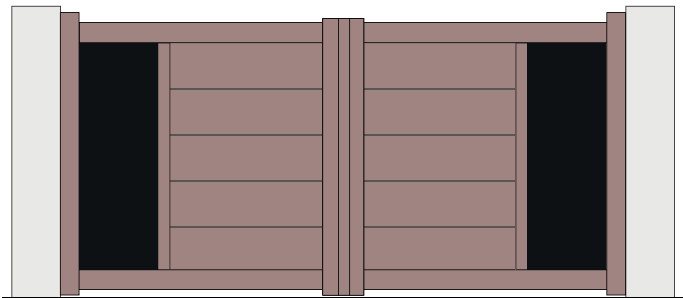

## Décors découpes laser Estampe



Lisse



Herbage



Horizon

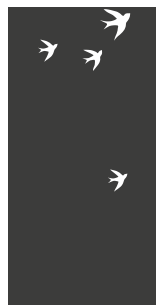

Échappée



Odyssée



Éclat



Brindille



Ramage



Dispersion



Variation

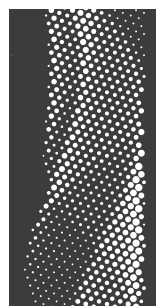

Mirage



Rêverie



Ombrage



Alchimie



Futuriste

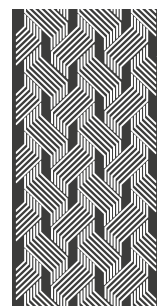

Symétrie

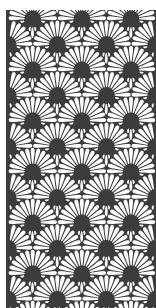

Évasion

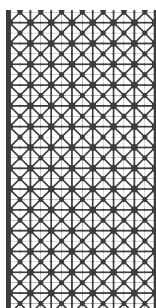

Impulsion



Balade

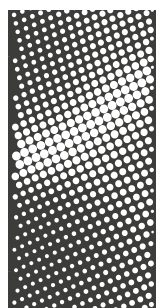

Reflét



Féerie

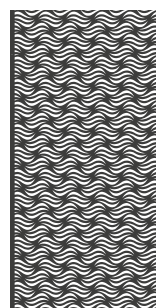

Oscillation

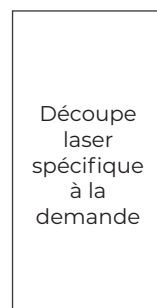

Découpe laser  
spécifique à la  
demande

---

# Personnalisation

## Décors tôles perforées

---

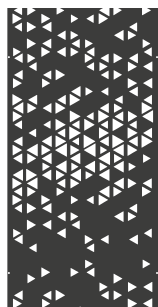

Prisme

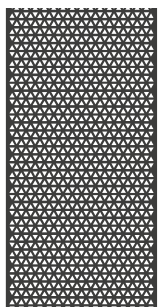

Exa

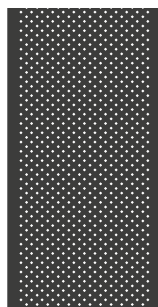

Diamant



Ellipses

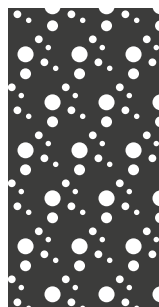

Bulles de  
savon

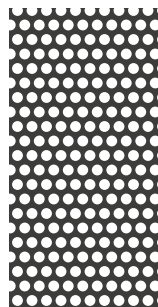

Ronds

## Décors panneaux design

---

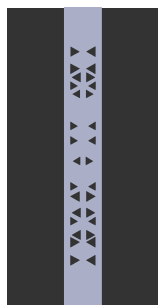

Prisme

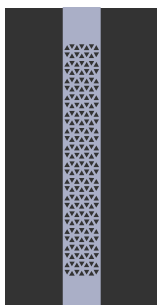

Exa

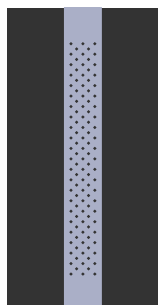

Diamant

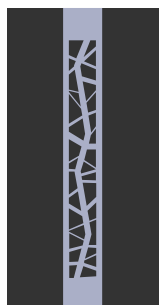

Arte

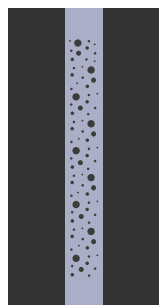

Bulles de  
savon

## Décors vitrages

---



Vitres opalescentes  
(blanc dépoli)

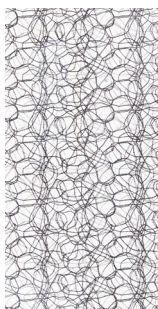

Maille  
(vitrage textile  
incrusté)

## Décors parement de pierre

---



Mica



Ardoise

## Décors alu anodisé

---



Hygie



Estacade

## Lisses 60 x 18

---

