

# ASTER BATTANT



Gamme Signature



Plein



Battant



Prix moyen

## Nuancier



+ Nuancier RAL  
hors-standard  
en option



## Labels



Thermolaquage  
haute durabilité  
CLASSE 2

# Caractéristiques techniques

## Design :

Lignes fluides et épurées.

Finitions parfaites : poignée et rosace en aluminium anodisé.

Personnalisation grâce à de nombreux décors disponibles.

Possibilité d'assortir sa clôture à son portail pour un extérieur parfaitement coordonné.

## Remplissage :

Lame large 255 x 18 (horizontal et vertical).

Lame large 170 x 18 (horizontal et vertical).

Lame brise-vent 150 x 25 (horizontal et vertical).



Lames larges 255 x 18



Lames larges 170 x 18

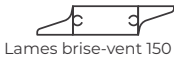

Lames brise-vent 150 x 25

## Dimensions :

Min H 900 x L 2000 mm pour toutes lames.

Max H 2000 x L 5000 mm (crapaudines incluses à partir de 4251 mm) pour les lames 255 et 170.

Max H 2000 x L 4250 mm pour les lames brise-vent.

## Structure technique :

Assemblage tenon-mortaise.

Montant 110 x 70.

Traverse 100 x 40.

Oreille de gond profilée.

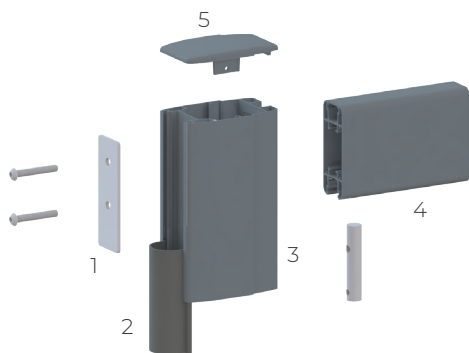

1- Cale 118 x 40 x 4  
2- Joint anti-pince-doigts

4- Traverse 100 x 40  
5- Chapeau de finition extraplat

## Sécurité :

Vis et système anti-dégondage.

Joint anti pince-doigts.

## Accessoires fournis :

Gonds à visser 2 points avec cache ou à sceller réglables inox disposition type A.

Serrure avec barillet finition Oxyloc 5 clés.

Poignée et rosace pour barillet en aluminium anodisé.

Sabot arrêt central pour portail.

Arrêt à bascule.

Pivot crapaudine suivant dimension.

Visserie de pose en inox incluse.

Réhausse de sabot.

## Options :

Numéro de rue.

Bâton de maréchal.

## Motorisation :

V418 - BA 392 - E770 - Axovia - MI24

Motorisation connectée : box Tydom Home Deltadore, box Tahoma Somfy.

## Poteaux :

150 M avec embase.

150 et 200 M avec scellement.

## Types de pose :

A : Gond 2 points entre piliers

C : Pivot crapaudine entre piliers

H : Gond pour pente entre piliers

D : Gond 3 points

F : Gond 3 points arrière piliers

G : Pivot crapaudine arrière piliers

# Personnalisation

■ Emplacement des zones de décor pour le portail battant Aster.

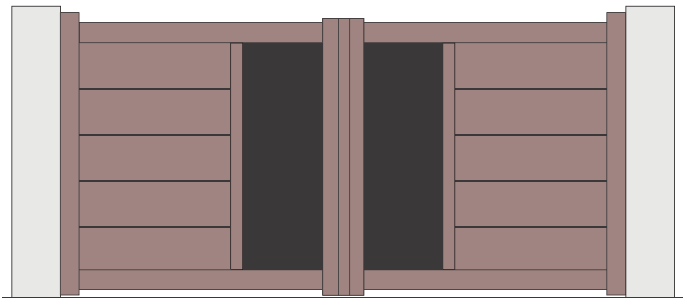

## Décors découpes laser Estampe

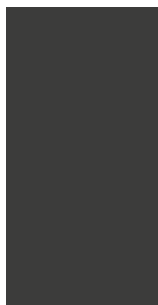

Lisse



Herbage



Horizon

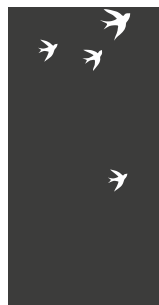

Échappée



Odyssée



Éclat



Brindille



Ramage



Dispersion



Variation

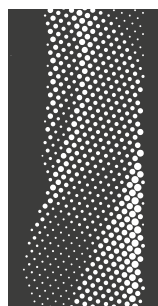

Mirage



Rêverie



Ombrage



Alchimie



Futuriste

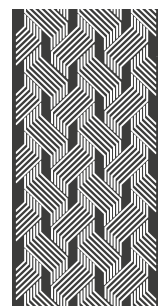

Symétrie

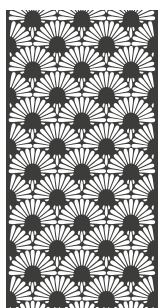

Évasion

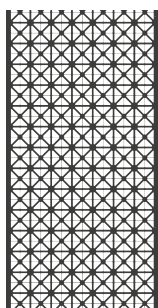

Impulsion



Balade

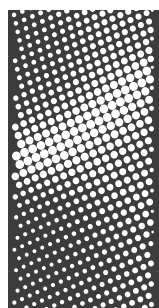

Reflét

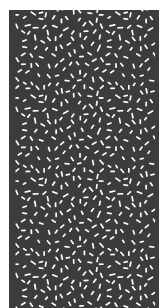

Féerie

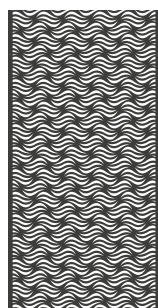

Oscillation

Découpe laser spécifique à la demande

---

# Personnalisation

## Décors tôles perforées

---

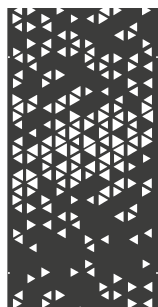

Prisme

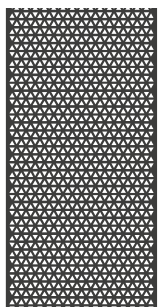

Exa

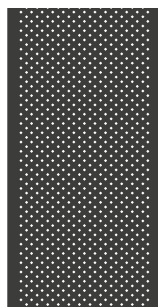

Diamant



Ellipses

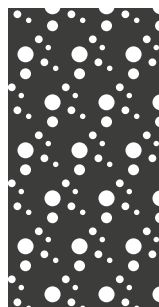

Bulles de  
savon

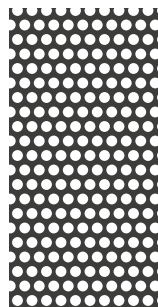

Ronds

## Décors panneaux design

---

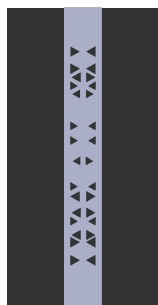

Prisme

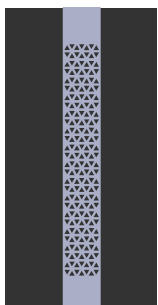

Exa

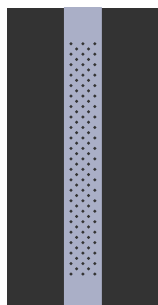

Diamant

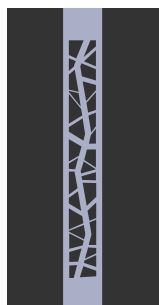

Arte

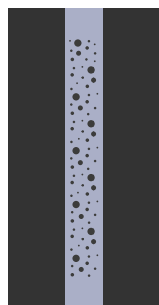

Bulles de  
savon

## Décors vitrages

---



Vitres opalescentes  
(blanc dépoli)

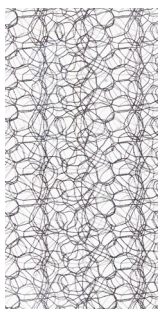

Maille  
(vitrage textile  
incrusté)

## Décors parement de pierre

---



Mica



Ardoise

## Décors alu anodisé

---



Hygie



Estacade

## Lisses 60 x 18

---

