

NORDICA BATTANT



Gamme Signature



Plein



Battant



Prix moyen

Nuancier



+ Nuancier RAL
hors-standard
en option



Labels



Thermolaquage
haute durabilité
CLASSE 2

Caractéristiques techniques

Design :

Lignes fluides et épurées.
Finitions parfaites : poignée et rosace en aluminium anodisé.
Personnalisation grâce à de nombreux décors disponibles.
Possibilité d'assortir sa clôture à son portail pour un extérieur parfaitement coordonné.

Remplissage :

Lame large 255 x 18 (horizontal, M ou H).
Lame large 170 x 18 (horizontal, M ou H).



Lames larges 255 x 18



Lames larges 170 x 18

Dimensions :

Min H 900 x L 2000 mm pour toutes lames.
Max H 2000 x L 5000 mm (crapaudines incluses à partir de 4251 mm) pour les lames 255 et 170.

Structure technique :

Assemblage tenon-mortaise.
Montant 110 x 70.
Traverse 100 x 40.
Oreille de gond profilée.

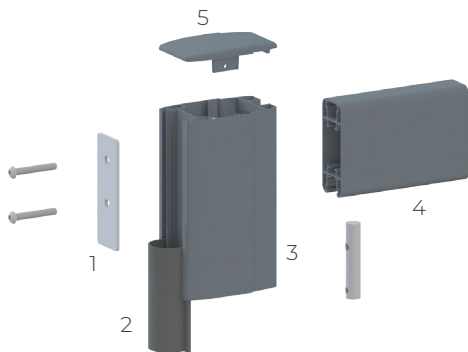

1- Cale 118 x 40 x 4
2- Joint anti-pince-doigts
3- Montant 110 x 70

4- Traverse 100 x 40
5- Chapeau de finition extraplat

Sécurité :

Vis et système anti-dégondage.
Joint anti pince-doigts.

Accessoires fournis :

Gonds à visser 2 points avec cache ou à sceller réglables inox disposition type A.
Serrure avec barillet finition Oxyloc 5 clés.
Poignée et rosace pour barillet en aluminium anodisé.
Sabot arrêt central pour portail.
Arrêt à bascule.
Pivot crapaudine suivant dimension.
Visserie de pose en inox incluse.
Réhausse de sabot.

Options :

Numéro de rue.
Bâton de maréchal.

Motorisation :

V418 - BA 392 - E770 - Axovia - MI24
Motorisation connectée : box Tydom Home Deltadore, box Tahoma Somfy.

Poteaux :

150 M avec embase.
150 et 200 M avec scellement.

Types de pose :

A : Gond 2 points entre piliers
C : Pivot crapaudine entre piliers
H : Gond pour pente entre piliers
D : Gond 3 points
F : Gond 3 points arrière piliers
G : Pivot crapaudine arrière piliers

Personnalisation

■ Emplacement de la zone de décor (milieu ou haut) pour le portail battant Nordica.

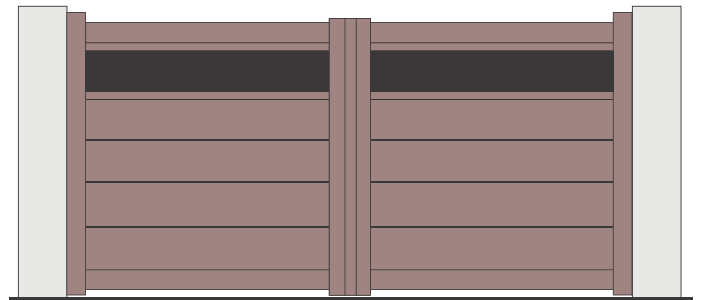
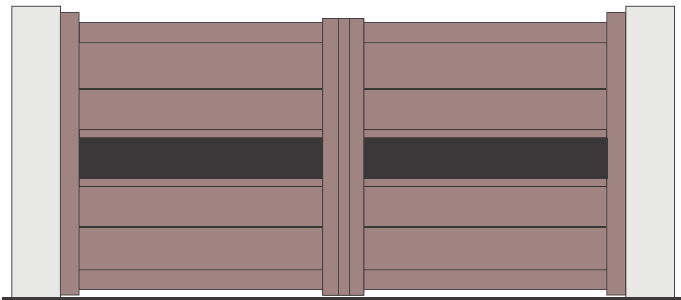

Décors découpes laser Estampe



Lisse



Horizon



Échappée



Odyssée



Éclat



Brindille



Ramage



Dispersion



Variation



Mirage



Rêverie



Ombrage



Alchimie



Futuriste



Symétrie



Évasion

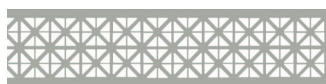

Impulsion



Balade

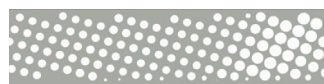

Reflet



Féérie

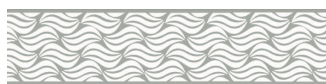

Oscillation

Découpe laser spécifique à la demande

Décors tôles perforées



Prisme

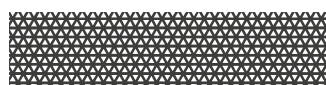

Exa



Diamant



Ellipses



Bulles de savon



Ronds

Personnalisation

Décors panneaux horizontaux



Arte



Labyrinthe

Décors vitrages



Vitre opale (blanc dépoli)



Maille (vitrage textile incrusté)

Décors parement de pierre



Mica

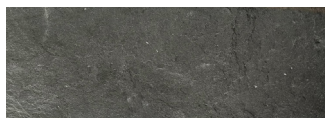

Ardoise

Décor alu anodisé



Hygie

Décor LED

