

TAHOMA BATTANT



Gamme Signature



Plein



Battant



Prix moyen

Nuancier



+ Nuancier RAL
hors-standard
en option



Labels



Thermolaquage
haute durabilité
CLASSE 2

Caractéristiques techniques

Design :

Lignes fluides et épurées.

Finitions parfaites : poignée et rosace en aluminium anodisé.

Personnalisation grâce à de nombreux décors disponibles.

Possibilité d'assortir sa clôture à son portail pour un extérieur parfaitement coordonné.

Remplissage :

Lame large 255 x 18 (horizontal et vertical).

Lame large 170 x 18 (horizontal et vertical).

Lame brise-vent 150 x 25 (horizontal et vertical).



Lames larges 255 x 18



Lames larges 170 x 18



Lames brise-vent 150 x 25

Dimensions :

Min H 900 x L 2000 mm pour toutes lames.

Max H 2000 x L 5000 mm (crapaudines incluses à partir de 4251 mm) pour les lames 255 et 170.

Max H 2000 x L 4250 mm pour les lames brise-vent.

Structure technique :

Assemblage tenon-mortaise.

Montant 110 x 70.

Traverse 100 x 40.

Oreille de gond profilée.

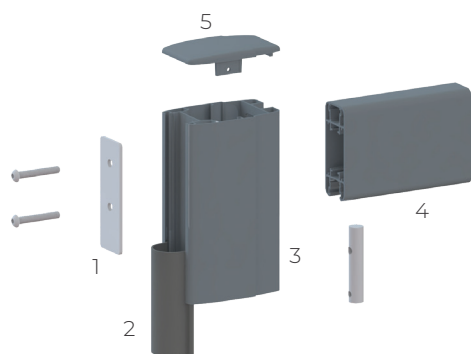

1- Cale 118 x 40 x 4

2- Joint anti-pince-doigts

3- Montant 110 x 70

4- Traverse 100 x 40

5- Chapeau de finition extraplat

Sécurité :

Vis et système anti-dégondage.

Joint anti pince-doigts.

Accessoires fournis :

Gonds à visser 2 points avec cache ou à sceller réglables inox disposition type A.

Serrure avec barillet finition Oxyloc 5 clés.

Poignée et rosace pour barillet en aluminium anodisé.

Sabot arrêt central pour portail.

Arrêt à bascule.

Pivot crapaudine suivant dimension.

Visserie de pose en inox incluse.

Réhausse de sabot.

Options :

Numéro de rue.

Bâton de maréchal.

Motorisation :

V418 - BA 392 - E770 - Axovia - MI24

Motorisation connectée : box Tydom Home Deltadore, box Tahoma Somfy.

Poteaux :

150 M avec embase.

150 et 200 M avec scellement.

Types de pose :

A : Gond 2 points entre piliers

C : Pivot crapaudine entre piliers

H : Gond pour pente entre piliers

D : Gond 3 points

F : Gond 3 points arrière piliers

G : Pivot crapaudine arrière piliers

Personnalisation

 Emplacement de la zone de décor pour le portail battant Tahoma.

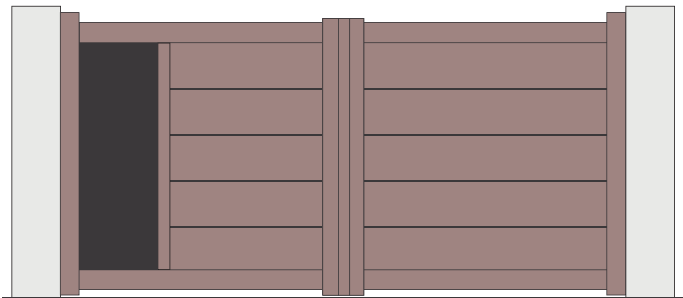

Décors découpes laser Estampe

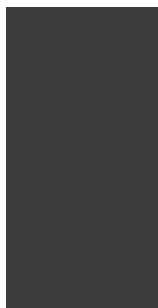

Lisse



Herbage



Horizon

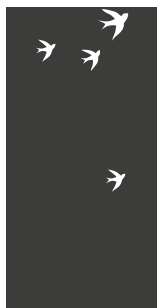

Échappée



Odyssée



Éclat



Brindille



Ramage



Dispersion



Variation

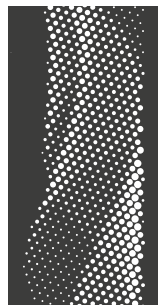

Mirage



Rêverie



Ombrage

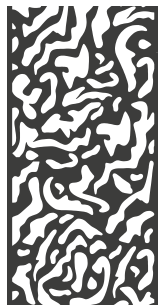

Alchimie

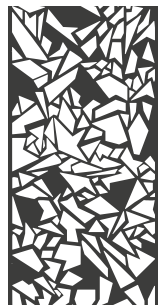

Futuriste

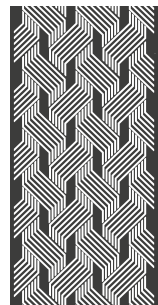

Symétrie

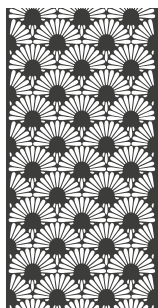

Évasion

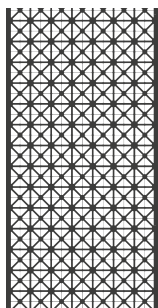

Impulsion



Balade

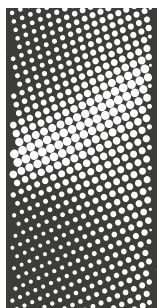

Reflét

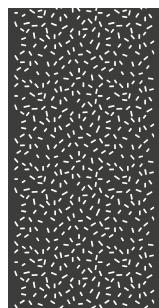

Féerie

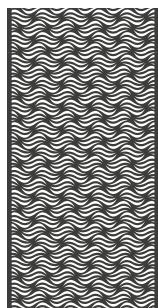

Oscillation

Découpe laser spécifique à la demande

Personnalisation

Décors tôles perforées

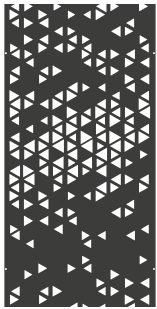

Prisme

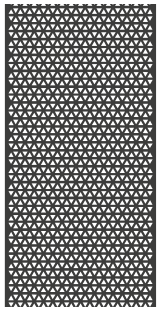

Exa

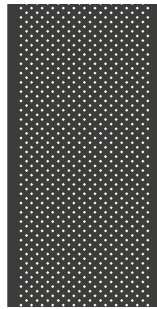

Diamant



Ellipses

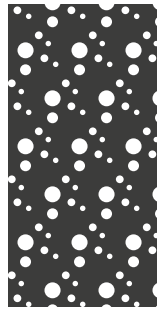

Bulles de
savon

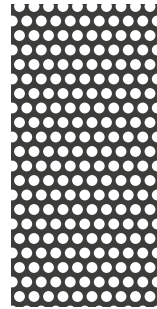

Ronds

Décors panneaux design

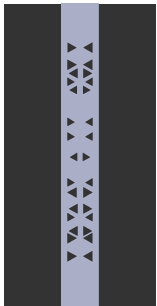

Prisme

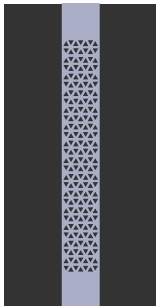

Exa

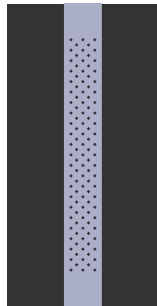

Diamant

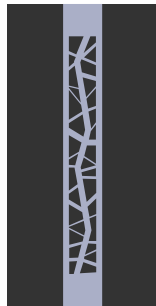

Arte

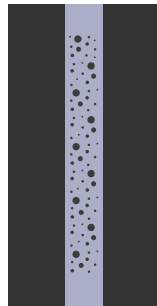

Bulles de
savon

Décors vitrages

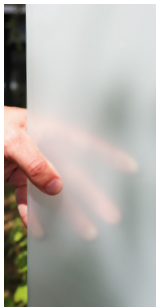

Vitres opalescentes
(blanc dépoli)

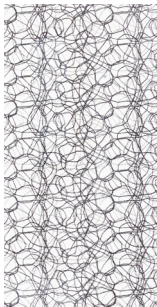

Maille
(vitrage textile
incrusté)

Décors parement de pierre



Mica



Ardoise

Décors alu anodisé



Hygie



Estacade

Lisses 60 x 18

